

Sürme Sistem
Sliding System

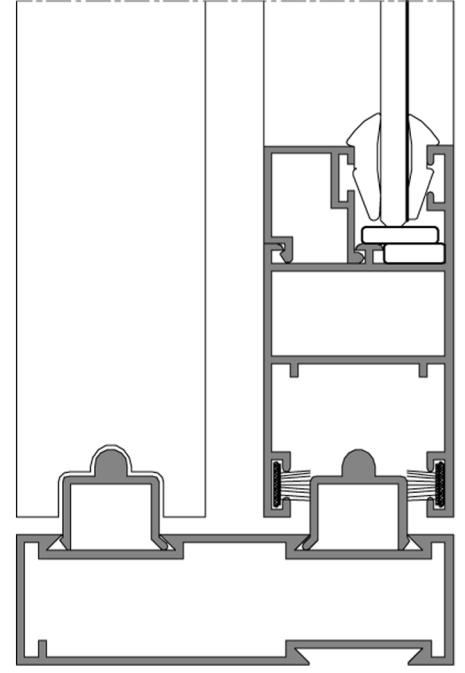

T S 29

Sürme Sistem
Sliding System









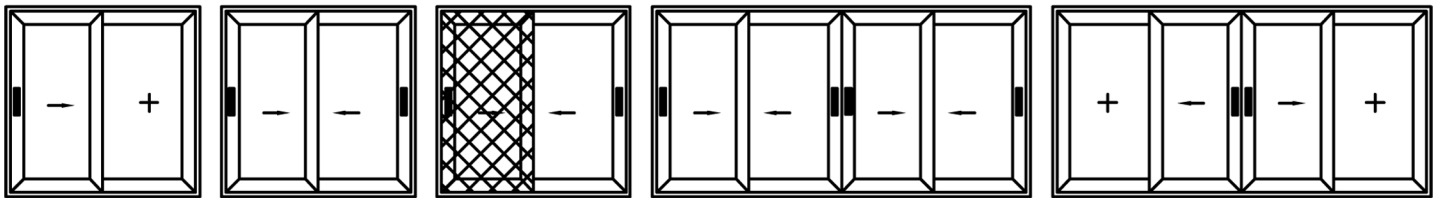

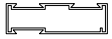
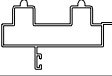
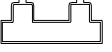
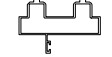

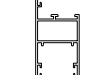
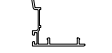
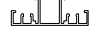

TEKNİK ÖZELLİKLER / TECHNICAL PROPERTIES

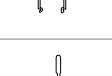
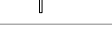
KASA DERİNLİĞİ / FRAME DEPTH	67 mm
KANAT DERİNLİĞİ / SASH DEPTH	29 mm
ET KALINLIĞI / WALL THICKNESS	1,2 – 1,3 mm
MIN/MAX CAM KALINLIĞI / MIN/MAX GLASS THICKNESS	4 - 20 mm
ISI BARIYER / THERMAL BREAK	-

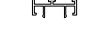
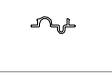
UYGULAMA SEÇENEKLERİ / APPLICATION OPTIONS



PROF L KES T PROFILE SECTION	PROF L KODU PROFILE CODE	PROF L ADI PROFILE NAME	Jx cm ⁴	Jy cm ⁴	A IRLIK (kg/m) WEIGHT
	130	KASA PROF L FRAME PROFILE	-	-	0,661 kg/mt
	143	KASA PROF L FRAME PROFILE	-	-	0,939 kg/mt
	1242	KASA PROF L FRAME PROFILE	-	-	0,779 kg/mt
	5329	KASA PROF L FRAME PROFILE	-	-	0,858 kg/mt
	258	ORTA KAYIT PROF L MULLION PROFILE	-	-	0,518 kg/mt
	132	KANAT PROF L SASH PROFILE	-	-	0,618 kg/mt
	135	KENET PROF L INTERLOCKING PROFILE	-	-	0,261 kg/mt
	12037	S NEKL K PROF L SCREENING PROFILE	-	-	0,534 kg/mt
	1243	S NEKL K PROF L SCREENING PROFILE	-	-	0,434 kg/mt
	131	RAY PROF L RAIL PROFILE	-	-	0,166 kg/mt
	290	RAY PROF L RAIL PROFILE	-	-	0,140 kg/mt
	1240	RAY PROF L RAIL PROFILE	-	-	0,285 kg/mt
	136	ADAPTÖR PROF L ADAPTER PROFILE	-	-	0,131 kg/mt
	134	ADAPTÖR PROF L ADAPTER PROFILE	-	-	0,302 kg/mt
	137	ORTA ADAPTÖR PROF L MULLION ADAPTER PROFILE	-	-	0,160 kg/mt
	1241	PERVAZ PROF L SILL PROFILE	-	-	0,390 kg/mt
	138	ÇITA PROF L BEAD PROFILE	-	-	0,173 kg/mt
	188	BA LANTI PROF L CONNECTION PROFILE	-	-	0,537 kg/mt
	141	ORTA KAYIT BA LANTI PROF L MULLION CONNECTION PROFILE	-	-	0,346 kg/mt
	413	KÖ E TAKOZ PROF L CORNER WEDGE PROFILE	-	-	3,667 kg/mt

AKSESUAR ACCESSORY	STOK KODU REFERENCE CODE	AKSESUAR ADI DESCRIPTION	AKSESUAR KODU PRODUCT CODE	PAKET PACK
	03 011230	Ç CAM F T L (EPDM) INNER GLAZING GASKET	TS29- CF.30	330 mt / paket 10 kg/mt
	03 011231	Ç CAM F T L (EPDM) INNER GLAZING GASKET	TS29- CF.40	205 mt / paket 10 kg/mt
	03 010732	Ç CAM F T L (EPDM) INNER GLAZING GASKET	TS29- CF.50	175 mt / paket 10 kg/mt
	03 070103	KAMA F T L 2300(3MM) SPLINE GASKET 2300 (3MM)	TS29-KMF.03	200 mt / paket 10 kg/mt
	03 070101	KAMA F T L 2209 (4MM) SPLINE GASKET 2209 (4 MM)	TS29-KMF.04	140 mt / paket 10 kg/mt
	06 140100	M N CAM TAKOZU (2.5X12X24 mm) GLAZING WEDGE (2.5 mm)	TS29-CT.100	1 pk / 1000ad
	03 050707	FIRÇA F T L (6.8 - 5.5 mm) WEATHER STRIP (6.8 - 5.5 mm)	TS29-FÇ.707	400 mt / pk
	01 050301	YAYLI TET K KOL (ELOKSALLI) TRIGGER HANDLE WITH SPRING (ANODIZED)	TS29-YTK.301	1 pk / 10ad
	01 050302	YAYLI TET K KOL (BEYAZ) TRIGGER HANDLE WITH SPRING (WHITE)	TS29-YTK.302	1 pk / 10ad
	01 050303	YAYLI TET K KOL (RENKL) TRIGGER HANDLE WITH SPRING (COLORED)	TS29-YTK.303	1 pk / 10ad
	01 050304	K L TL TET K KOL (BEYAZ) LOCKED TRIGGER HANDLE (WHITE)	TS29-KTK.304	1 pk / 10ad
	01 050305	K L TL TET K KOL (ELOKSALLI) LOCKED TRIGGER HANDLE (ANODIZED)	TS29-KTK.305	1 pk / 10ad
	01 110107	TEKL RULMAN SARI SINGLE ROLLER (GOLDEN)	TS29-SRG.107	1 pk / 50ad
	01 110112	Ç FTL RULMAN SARI DOUBLE ROLLER (GOLDEN)	TS45-DRG.112	1 pk / 50ad
	01 050750	FORZA YAYLI HAVUZ KOL (S YAH) FORZA RECESSED HANDLE AUTOMATIC (BLACK)	TS29-FHK.750	1 pk / 40ad
	01 050751	FORZA YAYLI HAVUZ KOL (BEYAZ) FORZA RECESSED HANDLE AUTOMATIC (WHITE)	TS29-FHK.751	1 pk / 40ad
	01 050752	FORZA YAYLI HAVUZ KOL (NATUREL) FORZA RECESSED HANDLE AUTOMATIC (NATURAL)	TS29-FHK.752	1 pk / 40ad
	01 050753	FORZA YAYLI HAVUZ KOL (ANTRAS T) FORZA RECESSED HANDLE AUTOMATIC (ANTHRACITE)	TS29-FHK.753	1 pk / 40ad
	01 050760	FORZA MANUEL HAVUZ KOL (S YAH) FORZA RECESSED HANDLE MANUEL (BLACK)	TS29-FHK.760	1 pk / 40ad
	01 050761	FORZA MANUEL HAVUZ KOL (BEYAZ) FORZA RECESSED HANDLE MANUEL (WHITE)	TS29-FHK.761	1 pk / 40ad
	01 050762	FORZA MANUEL HAVUZ KOL (NATUREL) FORZA RECESSED HANDLE MANUEL (NATURAL)	TS29-FHK.762	1 pk / 40ad
	01 050763	FORZA MANUEL HAVUZ KOL (ANTRAS T) FORZA RECESSED HANDLE MANUEL (ANTHRACITE)	TS29-FHK.763	1 pk / 40ad

AKSESUAR ACCESSORY	STOK KODU REFERENCE CODE	AKSESUAR ADI DESCRIPTION	AKSESUAR KODU PRODUCT CODE	PAKET PACK
	01 050770	FORZA ANAHTARLI HAVUZ KOL (S YAH) FORZA RECESSED HANDLE LOCK WITH KEY (BLACK)	TS29-FHK.770	1 pk / 40ad
	01 050771	FORZA ANAHTARLI HAVUZ KOL (BEYAZ) FORZA RECESSED HANDLE LOCK WITH KEY (WHITE)	TS29-FHK.771	1 pk / 40ad
	01 050772	FORZA ANAHTARLI HAVUZ KOL (NATUREL) FORZA RECESSED HANDLE LOCK WITH KEY (NATURAL)	TS29-FHK.772	1 pk / 40ad
	01 050773	FORZA ANAHTARLI HAVUZ KOL (ANTRAS T) FORZA RECESSED HANDLE LOCK WITH KEY (ANTHRACITE)	TS29-FHK.773	1 pk / 40ad
	01 050790	FORZA PAS F HAVUZ KOL (S YAH) FORZA RECESSED FINGER PULL HANDLE (BLACK)	TS29-FHK.790	1 pk / 40 ad
	01 050791	FORZA PAS F HAVUZ KOL (BEYAZ) FORZA RECESSED FINGER PULL HANDLE (WHITE)	TS29-FHK.791	1 pk / 40 ad
	01 050792	FORZA PAS F HAVUZ KOL (NATUREL) FORZA RECESSED FINGER PULL HANDLE (NATURAL)	TS29-FHK.792	1 pk / 40 ad
	01 050793	FORZA PAS F HAVUZ KOL (ANTRAS T) FORZA RECESSED FINGER PULL HANDLE (NATURAL)	TS29-FHK.753	1 pk / 40 ad
	01 050785	FORZA K L T D L (SAC) FORZA HOOK (SHEET)	TS29-FKD.785	1 pk / 40 ad
	01 050782	FORZA K L T KAR ILI I (ZAMAK) FORZA STRIKER (ZAMAK)	TS29-FKK.782	1 pk / 40 ad
	04 105018	S NEKL K HAVUZ KOL SCREENING ROLLER	TS29-SHK.018	100 ad / paket
	04 100120	S NEKL K KÖ E BA LANTI SCREENING CORNER CONNECTION	TS29-SÇ.150	4 ad / paket
	04 105070	S NEKL K KÖ E TAKOZ SCREENING CORNER WEDGE	TS29 - ST.070	100 ad / paket
	04 105060	S NEKL K RULMAN SCREENING ROLLER	TS29 - SR.060	100 ad / paket
	03 020114	S NEKL K F T L (4 mm) SCREENING GASKET (4 mm)	TS29 - SF.114	100 mt / paket
	03 020115	S NEKL K F T L (5 mm) SCREENING GASKET (5 mm)	TS29 - SF.115	
	03 020116	S NEKL K F T L (6 mm) SCREENING GASKET (6 mm)	TS29 - SF.116	
	04 060080 - 80cm	S NEKL K TULÜ SCREENING NET	TS29 - STF.80	24 ² m / paket
	04 060100 - 100cm		TS29 - STF.100	30 ² m / paket
	04 060120 - 120cm		TS29 - STF.120	36 ² m / paket
	04 060140 - 140cm		TS29 - STF.140	44 ² m / paket
	04 060160 - 160cm		TS29 - STF.160	48 ² m / paket

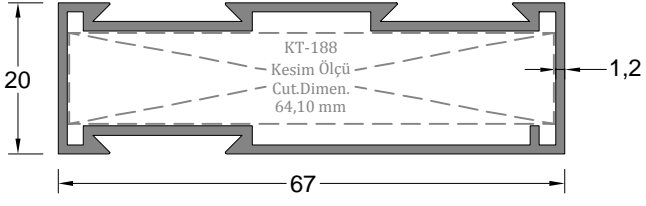

Kasa Profili	Profil Kodu	(kg/mt)
FRAME PROFILE	Profile Code	Weight
	130	0,661

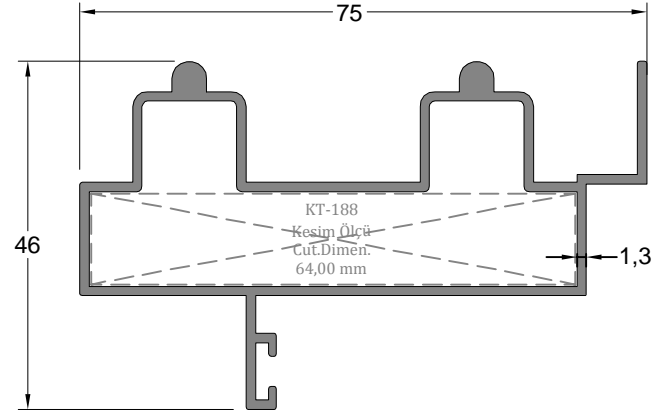

Kasa Profili	Profil Kodu	(kg/mt)
FRAME PROFILE	Profile Code	Weight
	143	0,939

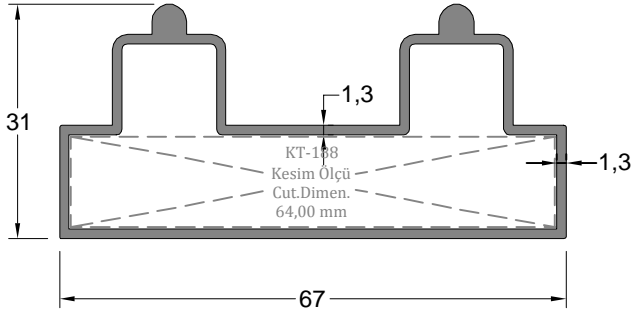

Kasa Profili	Profil Kodu	(kg/mt)
FRAME PROFILE	Profile Code	Weight
	1242	0,779

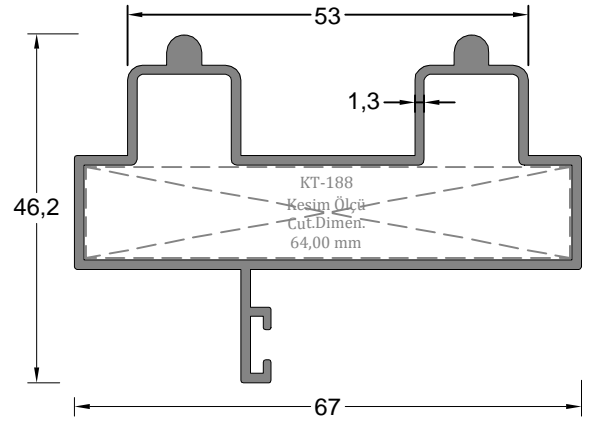

Kasa Profili	Profil Kodu	(kg/mt)
FRAME PROFILE	Profile Code	Weight
	5329	0,858

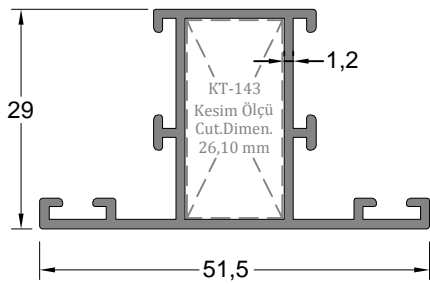

Orta Kayıt Profili	Profil Kodu	(kg/mt)
MULLION PROFILE	Profile Code	Weight
	258	0,518

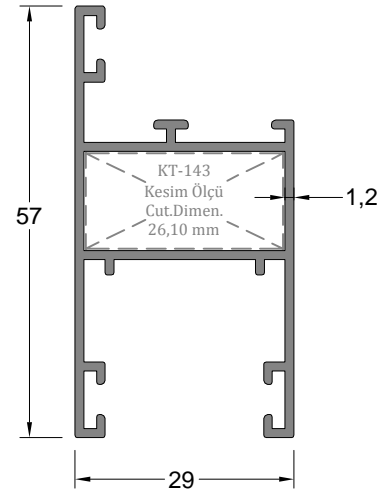

Kanat Profili	Profil Kodu	(kg/mt)
SASH PROFILE	Profile Code	Weight
	132	0,618

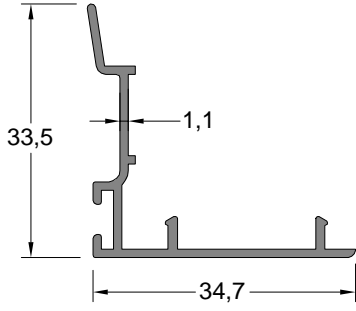

Kenet Profili	Profil Kodu	(kg/mt)
INTERLOCKING PROFILE	Profile Code	Weight
	135	0,261

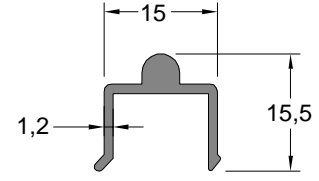

Ray Profili	Profil Kodu	(kg/mt)
RAIL PROFILE	Profile Code	Weight
	131	0,166

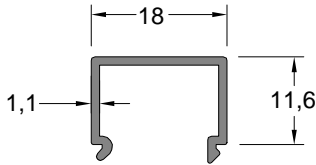

Ray Profili	Profil Kodu	(kg/mt)
RAIL PROFILE	Profile Code	Weight
	290	0,140

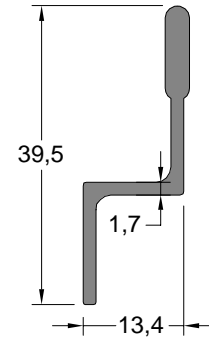

Ray Profili	Profil Kodu	(kg/mt)
RAIL PROFILE	Profile Code	Weight
	1240	0,285

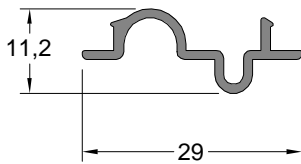

Orta Adaptör Profili	Profil Kodu	(kg/mt)
MULLION ADAPTER PROFILE	Profile Code	Weight
	137	0,160

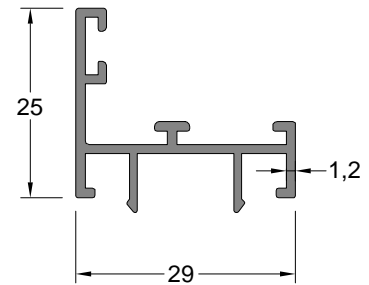

Adaptör Profili	Profil Kodu	(kg/mt)
ADAPTER PROFILE	Profile Code	Weight
	134	0,302

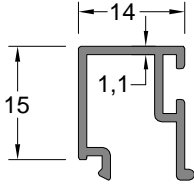

Çıta Profili	Profil Kodu	(kg/mt)
BEAD PROFILE	Profile Code	Weight
	138	0,173

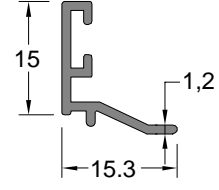

Çıta Profili	Profil Kodu	(kg/mt)
BEAD PROFILE	Profile Code	Weight
	136	0,131

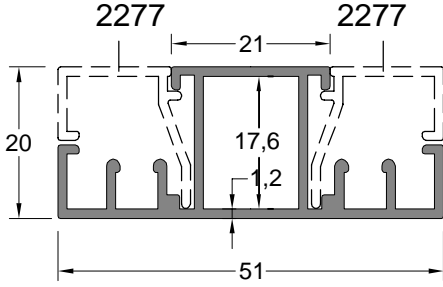

Sineklik Profili	Profil Kodu	(kg/mt)
SCREENING PROFILE	Profile Code	Weight
	12037	0,534

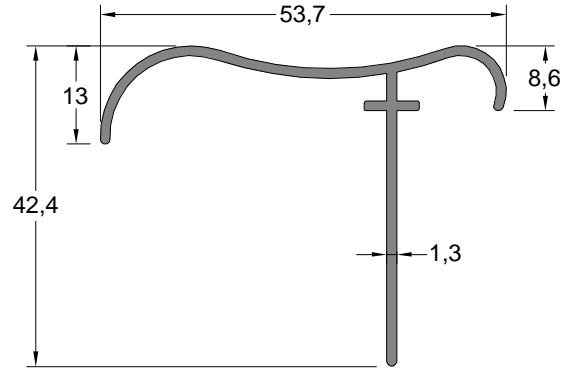

Pervaz Profili	Profil Kodu	(kg/mt)
SILL PROFILE	Profile Code	Weight
	1241	0,390

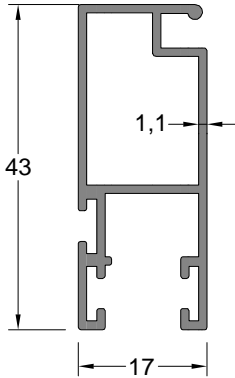

Sineklik Profili	Profil Kodu	(kg/mt)
SCREENING PROFILE	Profile Code	Weight
	1243	0,434



CAM ÇİTASI GLAZING BEAD (G)	CAM ÇİTASI UZUNLU U GLAZING BEAD LENGTH (L)	Ç CAM F T L GLAZING GASKET (INSIDE) (İ)	CAM KALINLI I GLASS THICKNESS (T)	DI CAM F T L GLAZING GASKET (OUTSIDE) (O)
138	14 mm	CF.40	4 mm	CF.30
138	14 mm	CF.30	5 mm	CF.30
138	14 mm	CF.50	6 mm	-
138	14 mm	-	8 mm	CF.30
138	14 mm	-	10 mm	-
136	14 mm	CF.40	17 mm	-
136	14 mm	-	20 mm	-

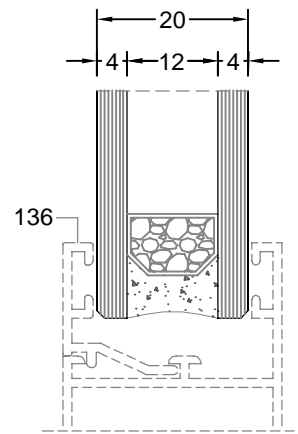
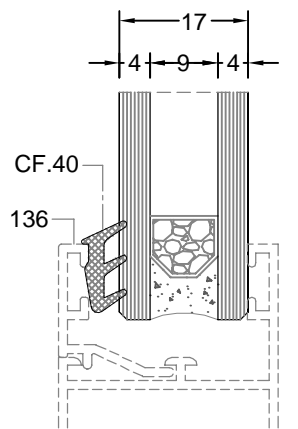
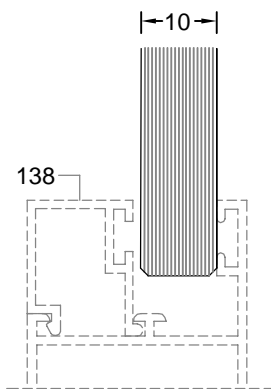
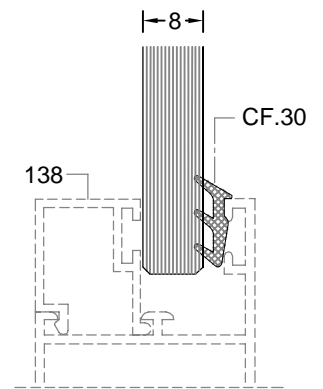
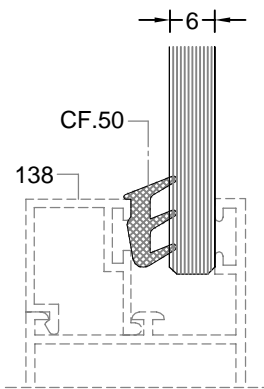
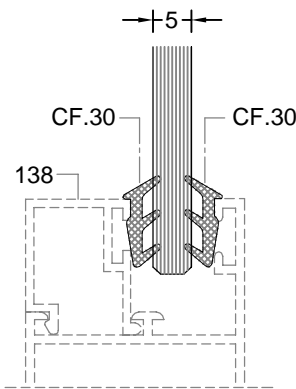
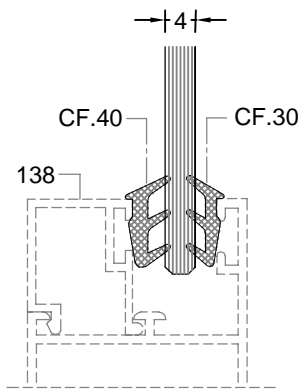
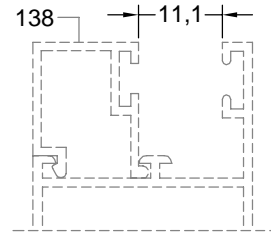
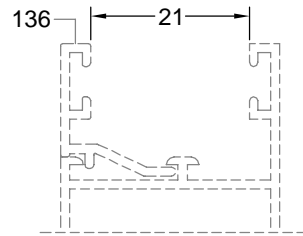

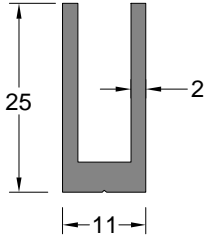

Dik Ba lantı Profili	Profil Kodu	(kg/mt)
MULLION CONNECTION PROFILE	Profile Code	Weight
	141	0,346

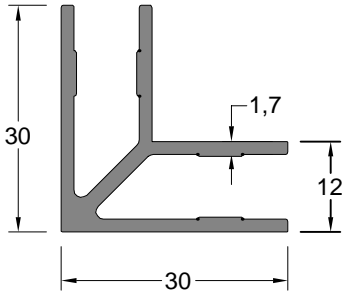

Kö e Takozu Profil Kodu	Kullanıldı ı Profil	Kesim Boyu (mm)
Corner Wedge Profile Code	Compatible Profile	Cutting Length (mm)
188	130	63,90 mm
	143	64,00 mm
	1242	64 mm
	5329	64 mm
	12037	17,1 mm

Kö e Çavı Ba lantı Profili	Profil Kodu	(kg/mt)
CORNER JOINT PROFILE	Profile Code	Weight
	188	0,537

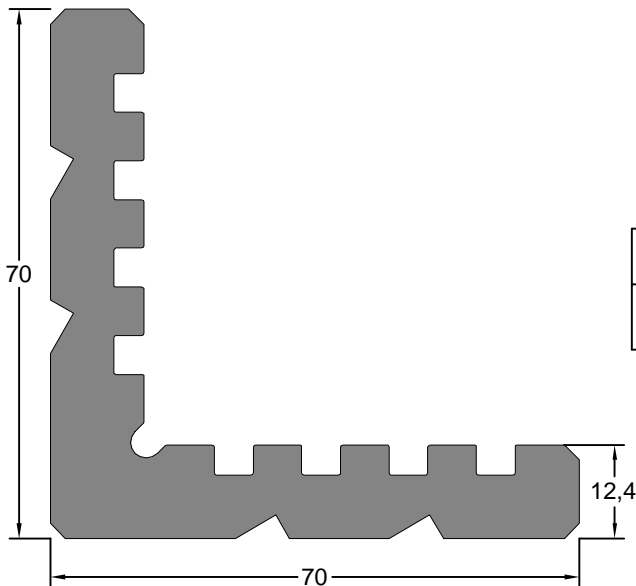

Kö e Takozu Profil Kodu	Kullanıldı ı Profil	Kesim Boyu (mm)
Corner Wedge Profile Code	Compatible Profile	Cutting Length (mm)
413	132	26,1 mm
	258	26,1 mm

Kö e Takoz Profili	Profil Kodu	(kg/mt)
CORNER WEDGE PROFILE	Profile Code	Weight
	413	3,667

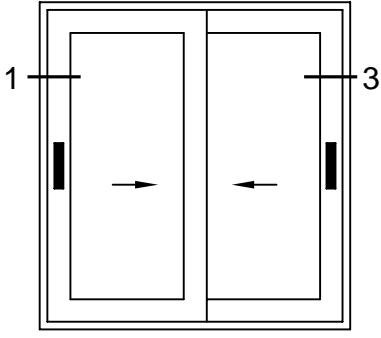

Ç
(INSIDE)

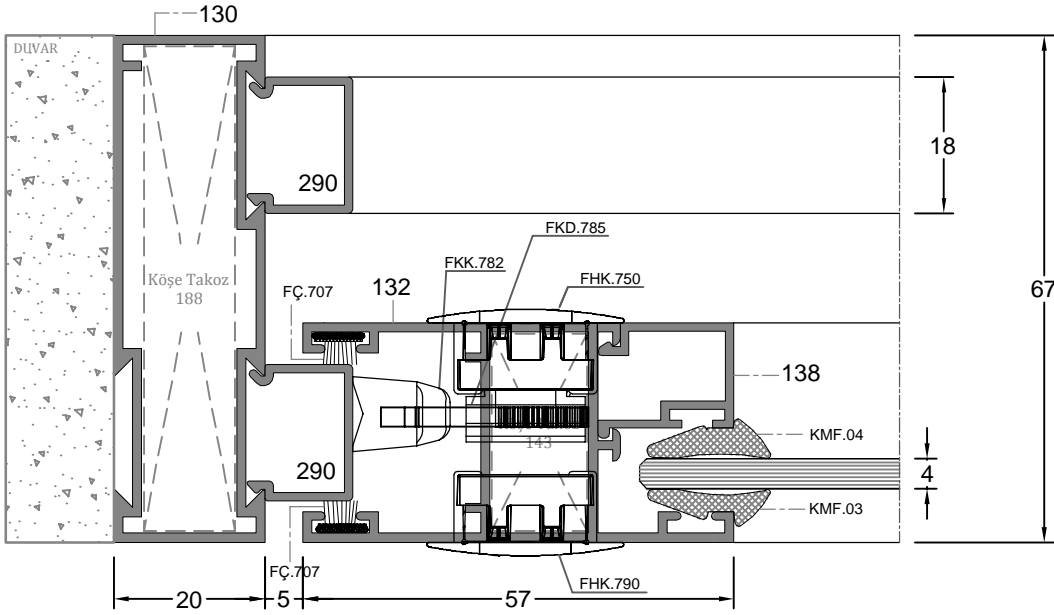

(D-1)

DI
(OUTSIDE)

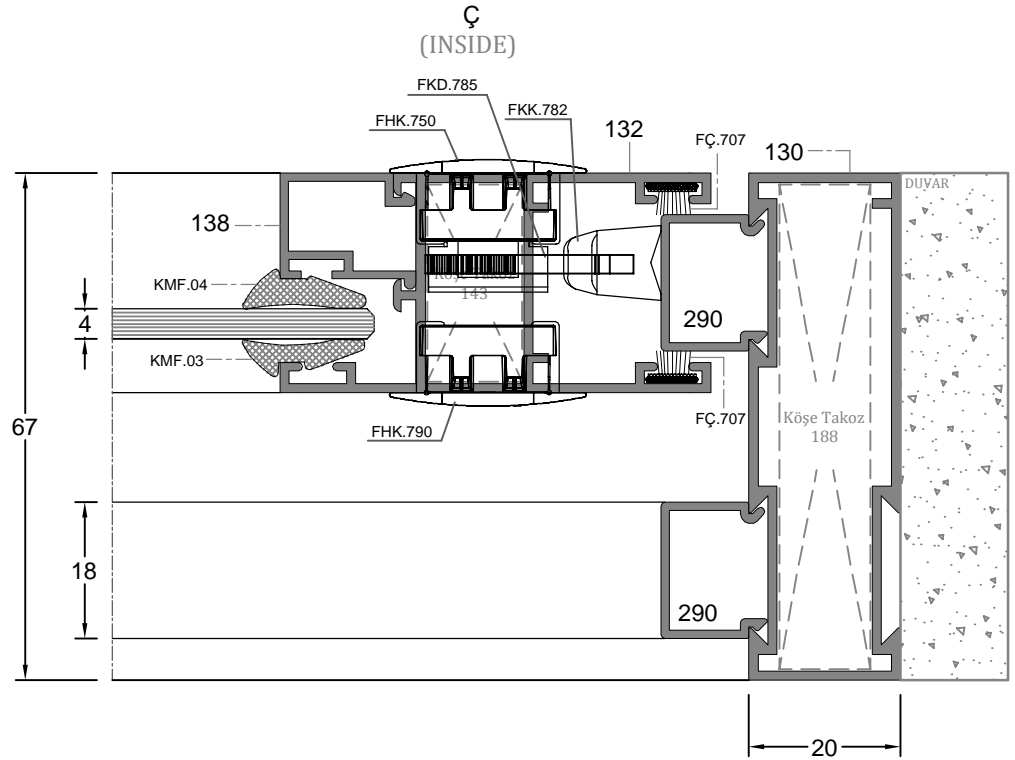

(D-3)

DI
(OUTSIDE)

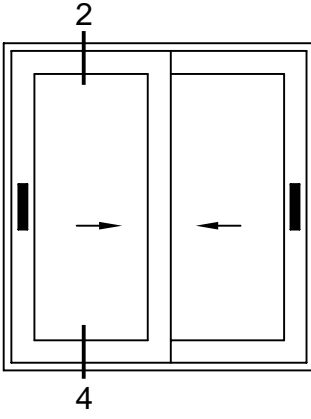

Ç
(INSIDE)

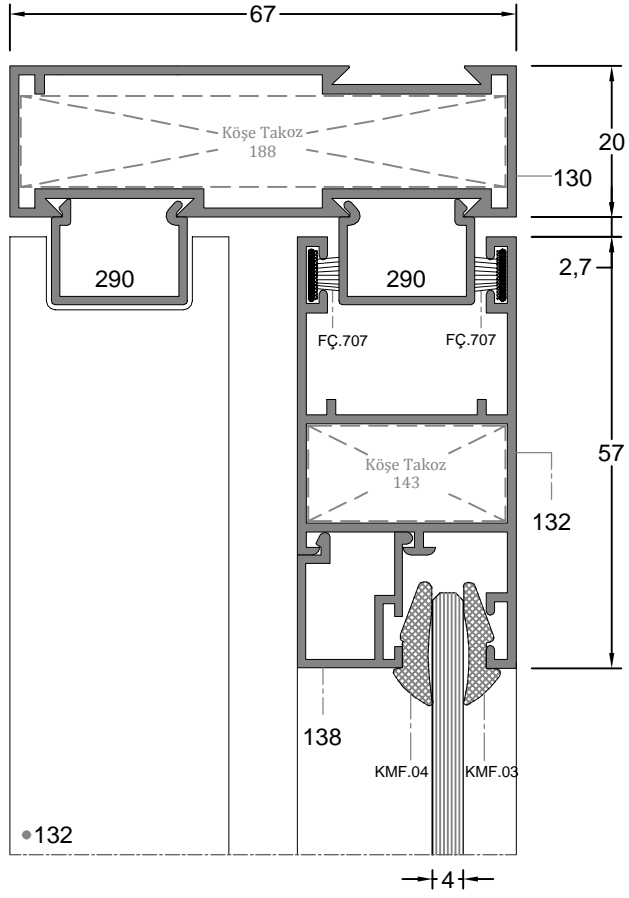

D-2

DI
(OUTSIDE)

Ç
(INSIDE)

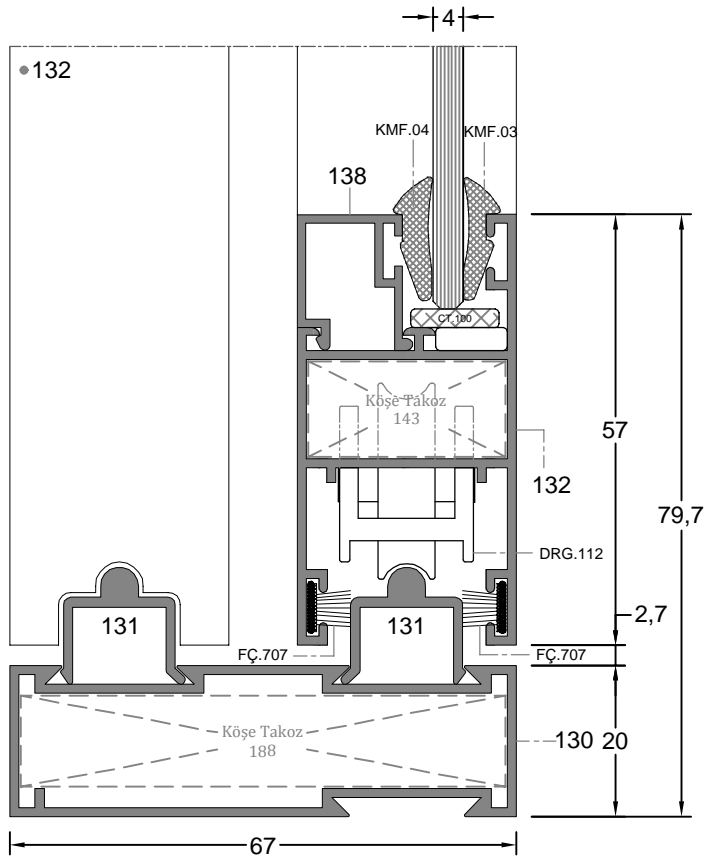

DI
(OUTSIDE)

D-4

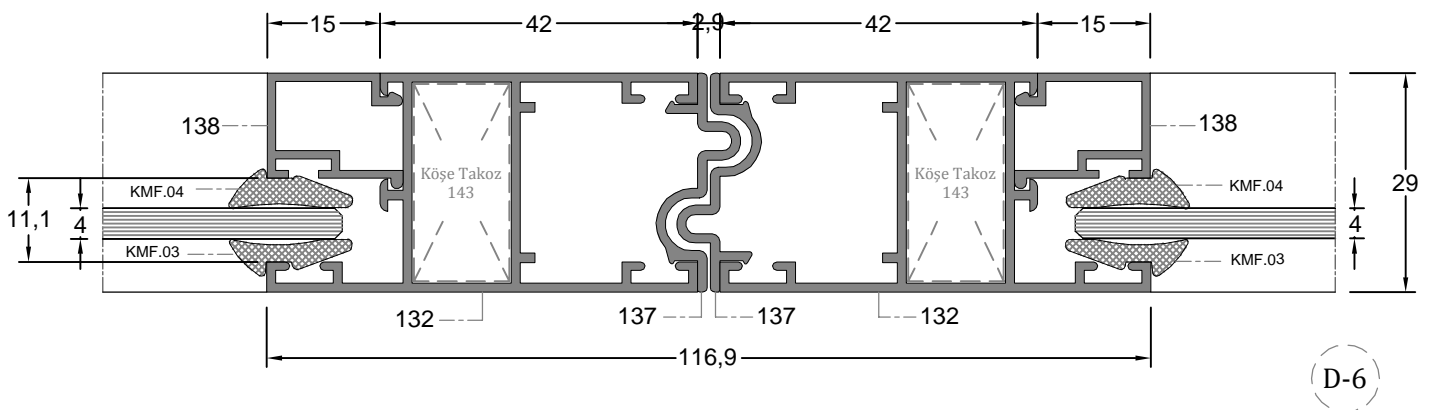
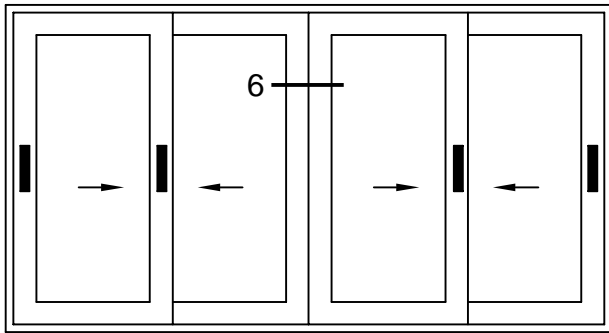
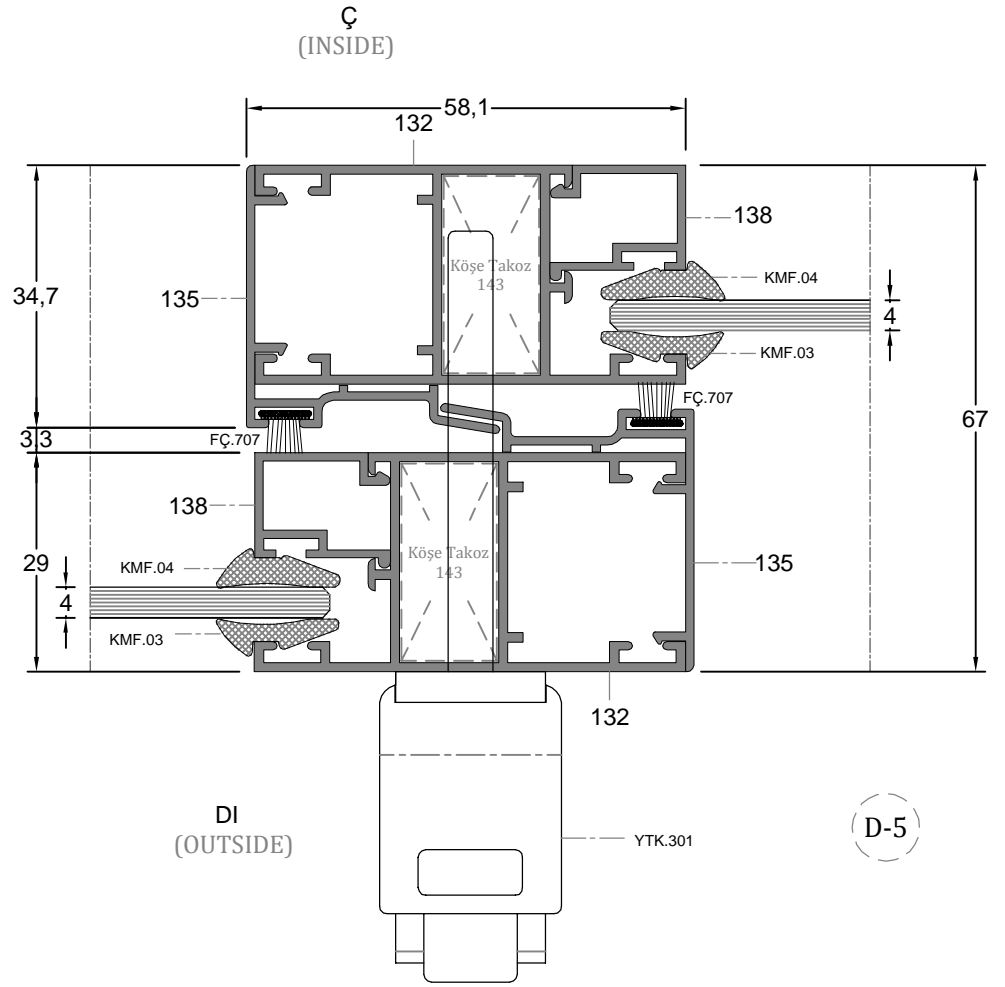
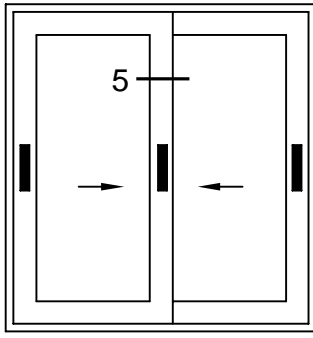

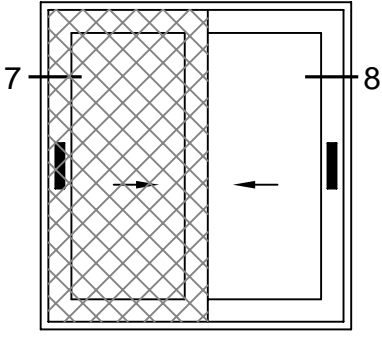

Ç
(INSIDE)

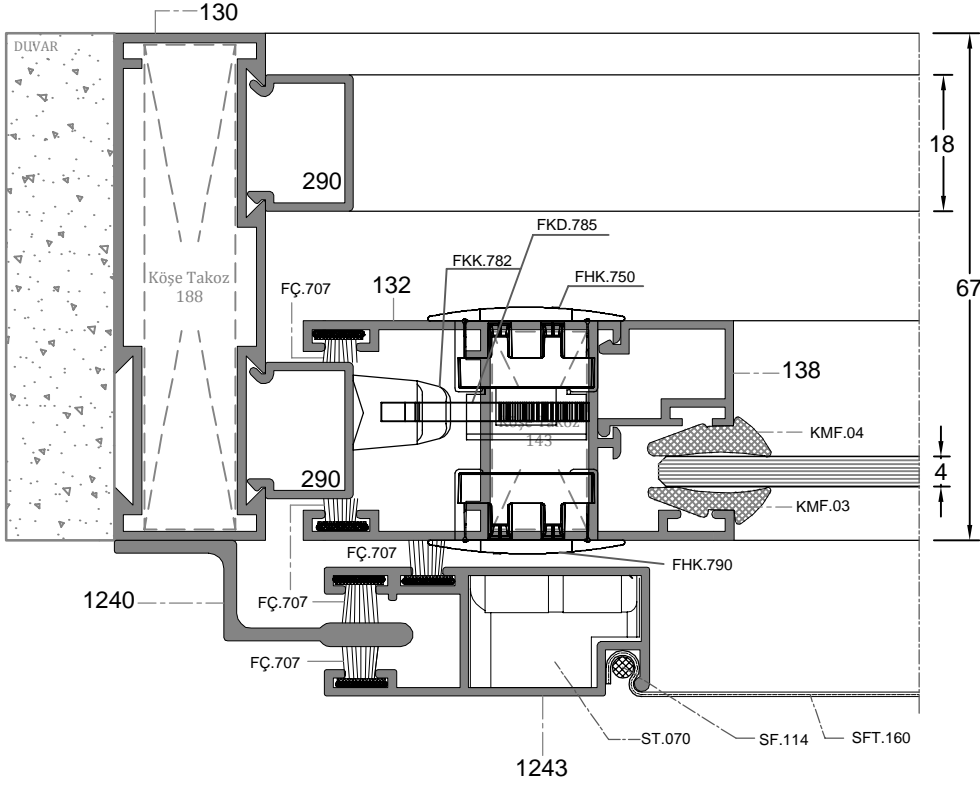

DI
(OUTSIDE)

D-7

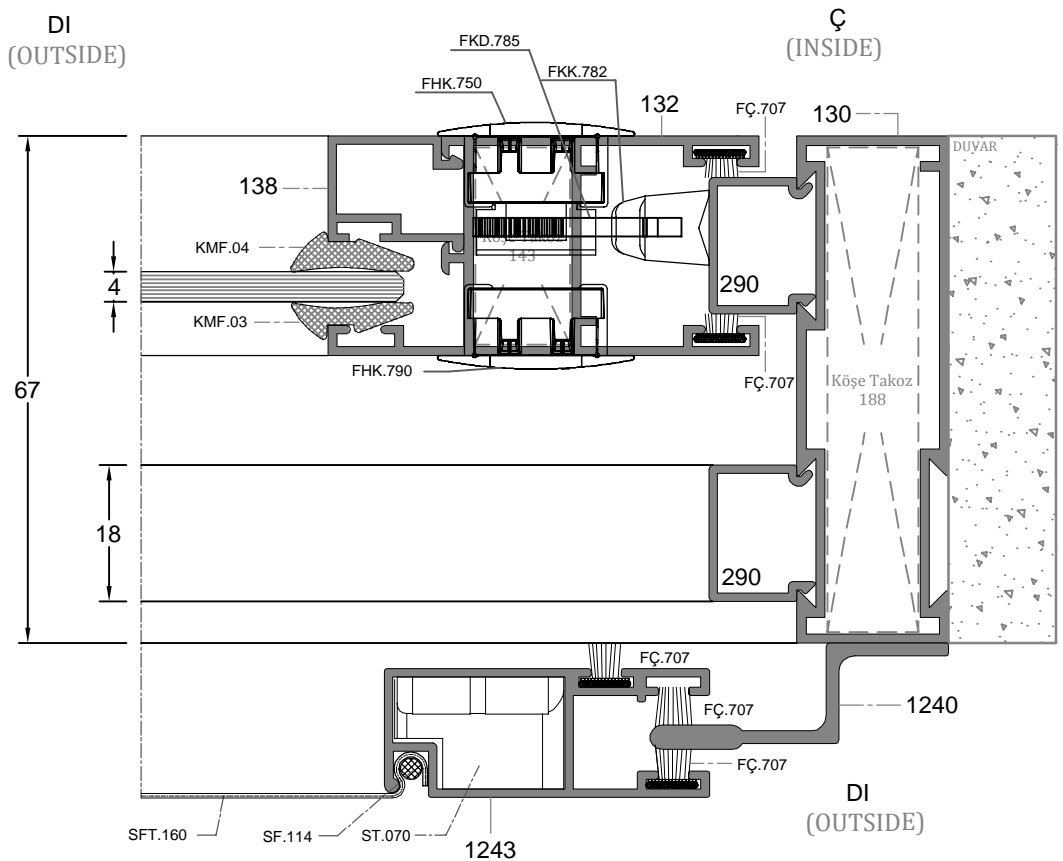

Ç
(INSIDE)

D-8

DI
(OUTSIDE)

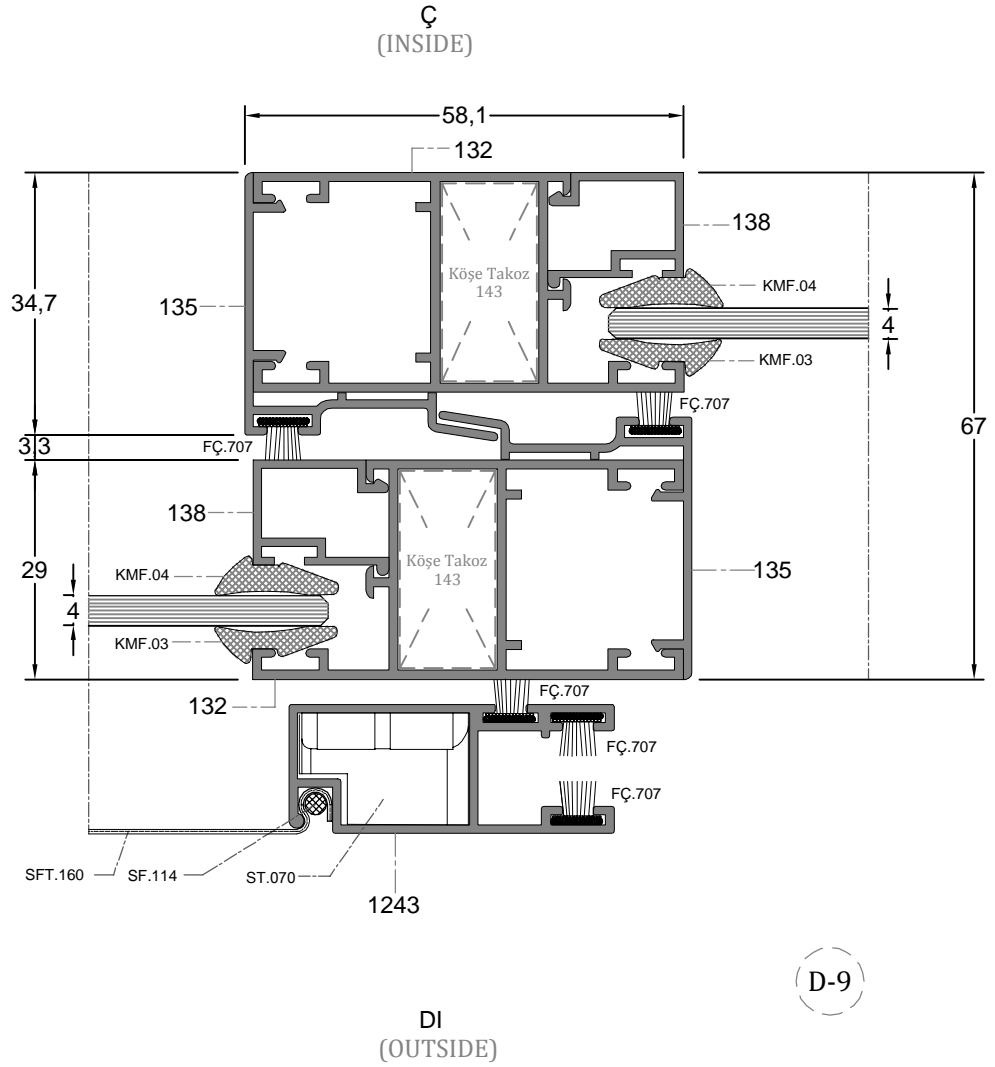
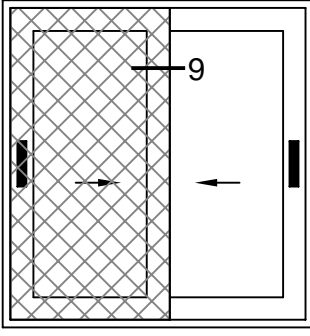

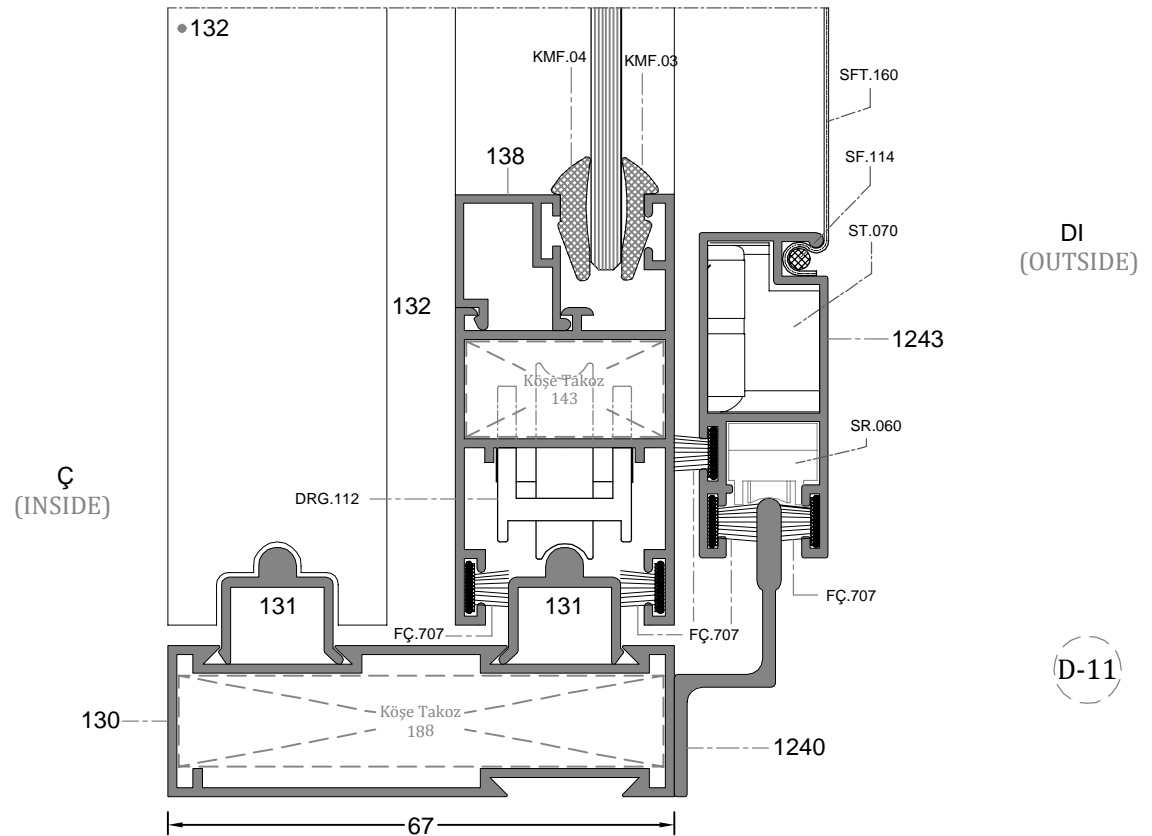
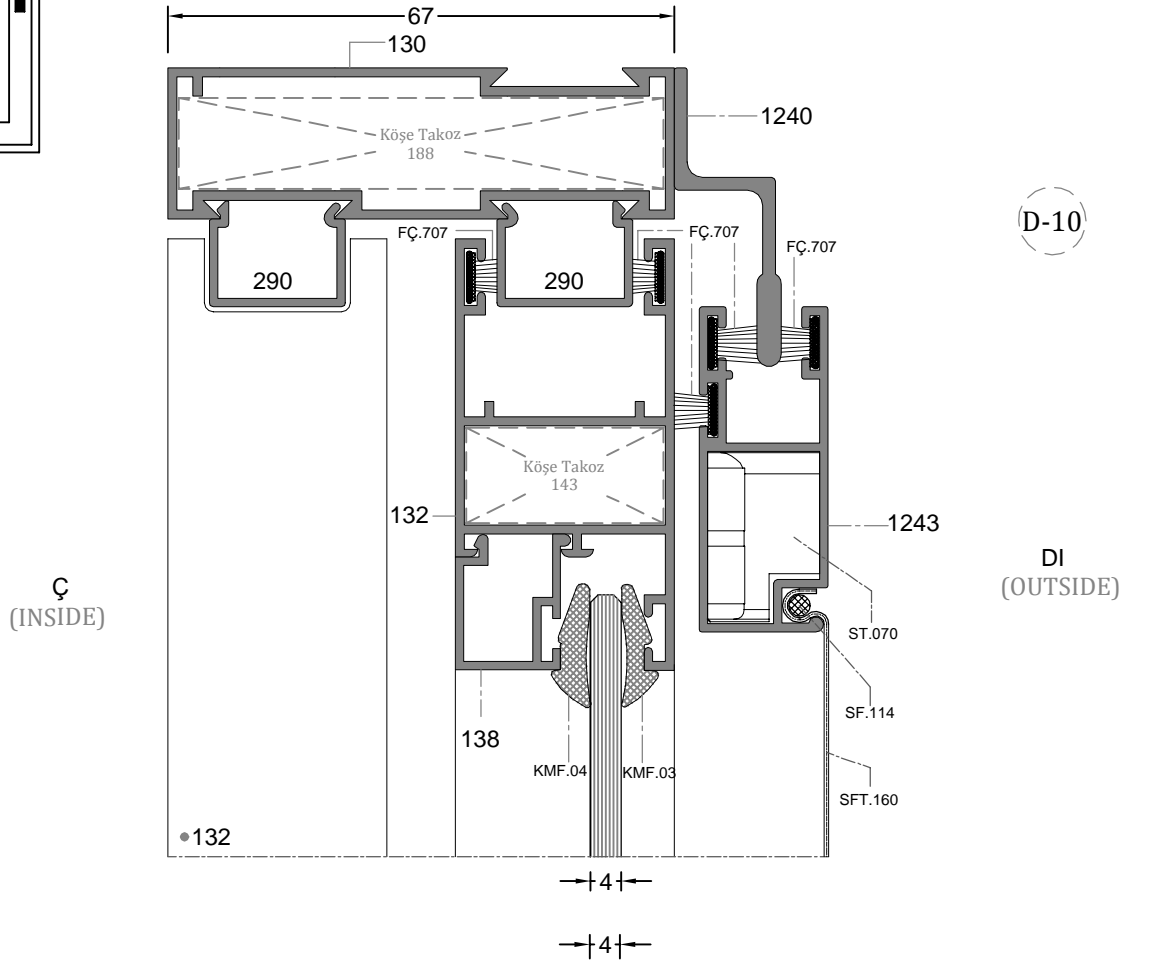
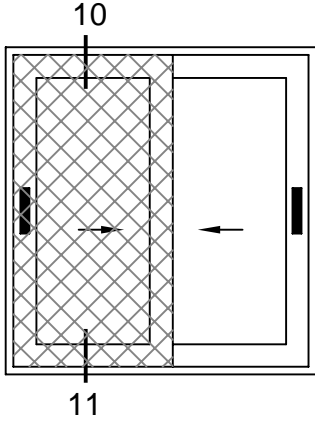

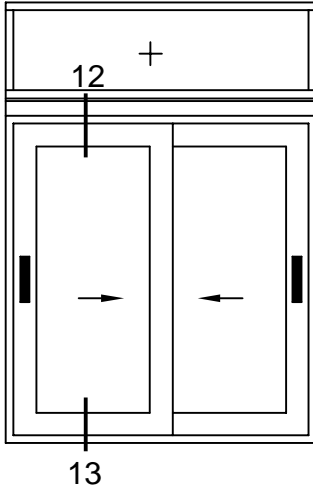

Ç
(INSIDE)

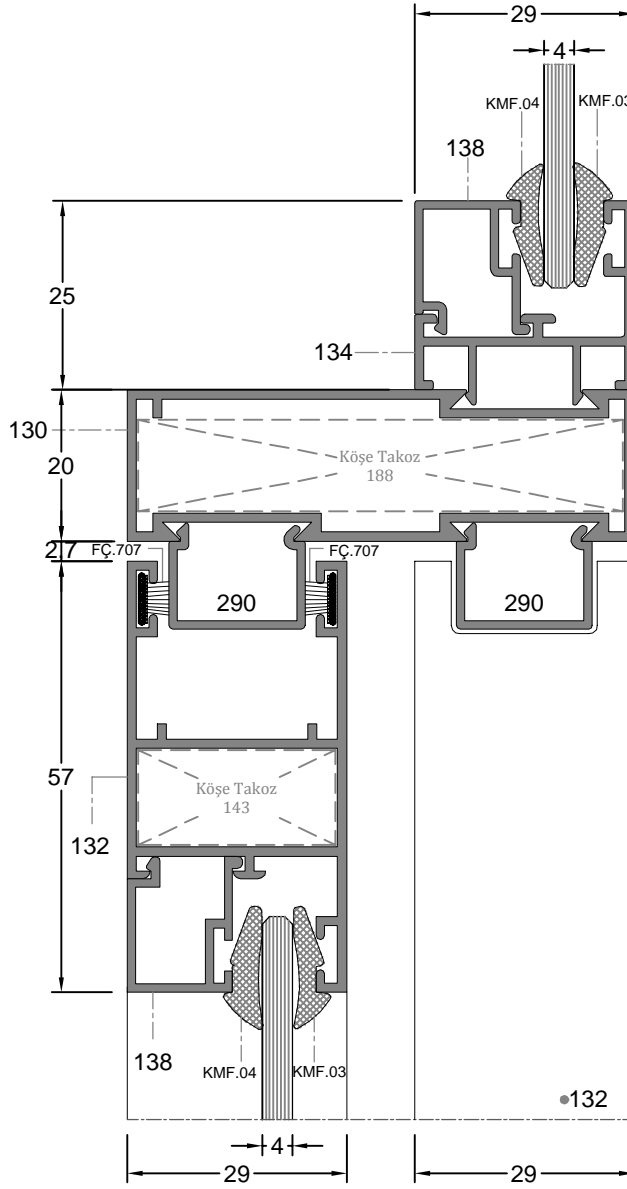

DI
(OUTSIDE)

D-12

Ç
(INSIDE)

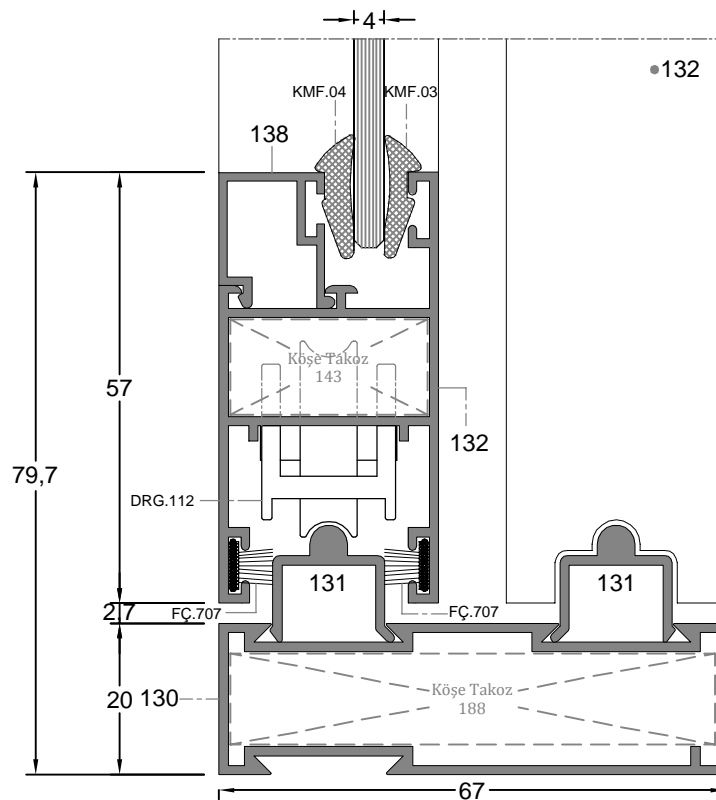

DI
(OUTSIDE)

D-13

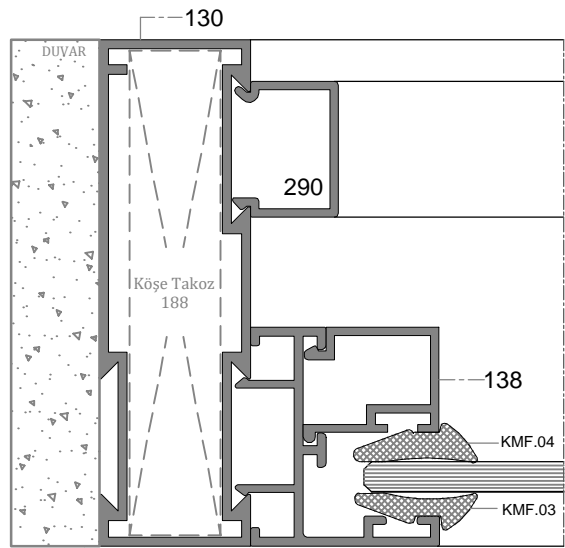
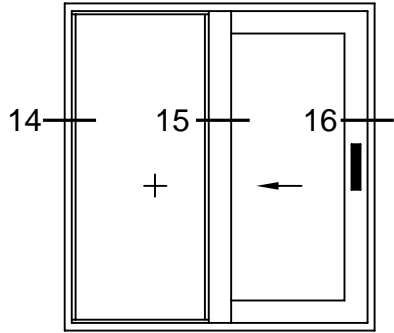

D-14

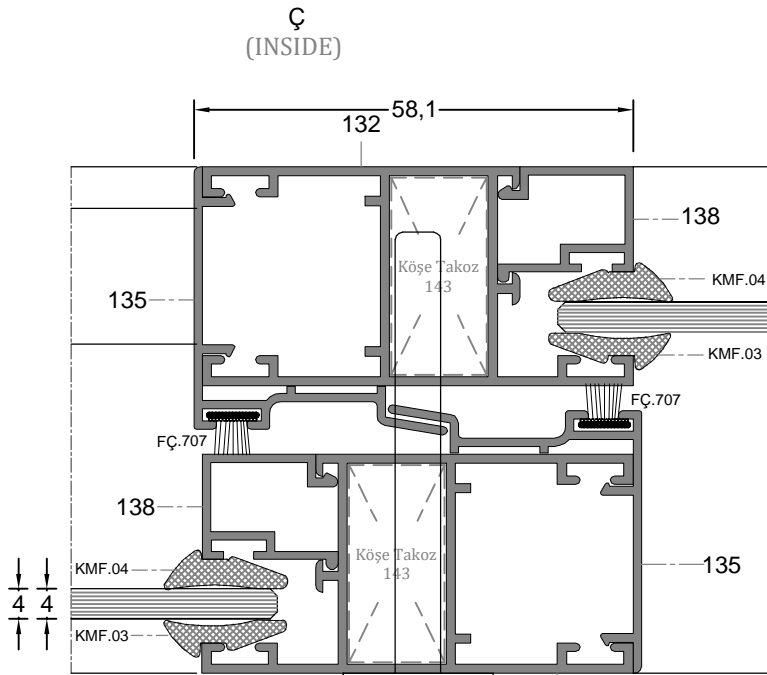

DI
(OUTSIDE)

D-15

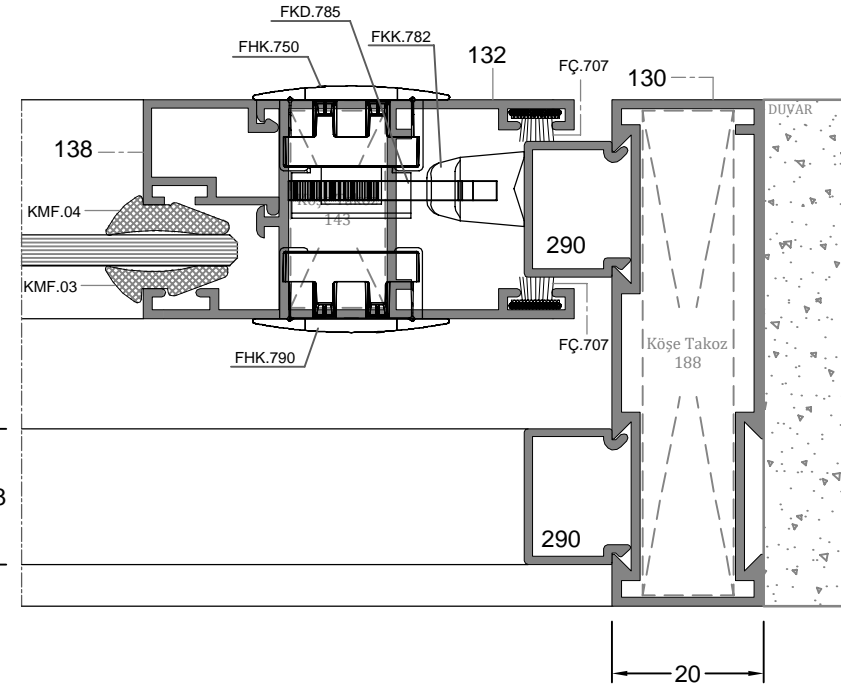

D-16

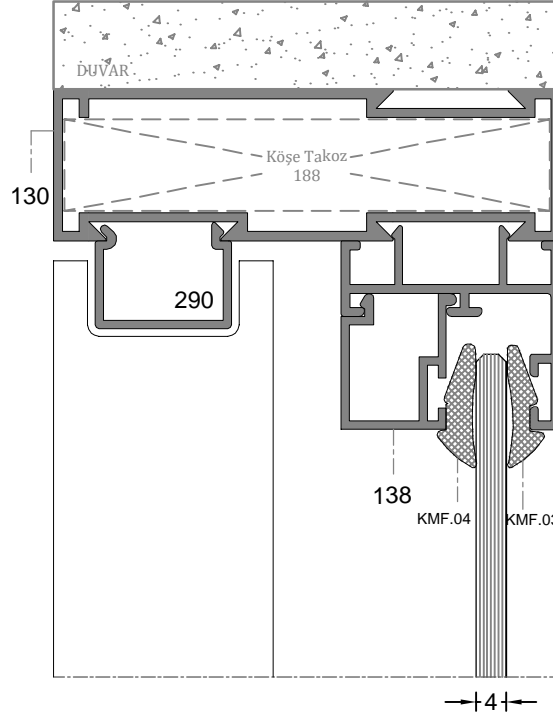
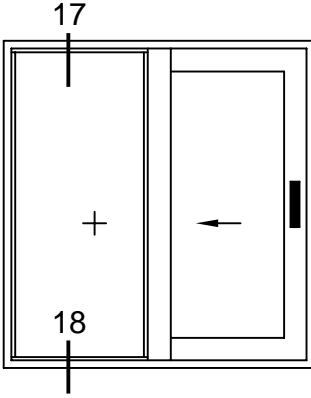

D-17

Ç
(INSIDE)

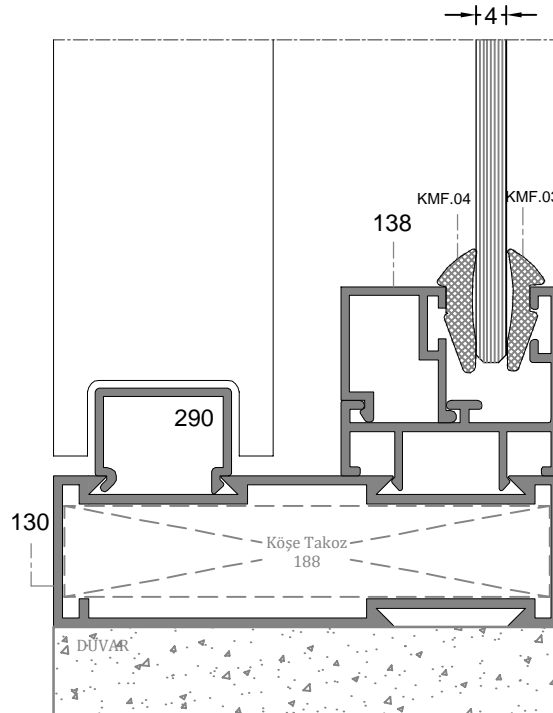

DI
(OUTSIDE)

D-18